

# PIPE FITTINGS AND ACCESSORIES



**10+** years of the experience in  
ferrous & non-ferrous metals

[www.onetouchexim.com](http://www.onetouchexim.com)

EXPORTER OF  
**FERROUS & NON-FERROUS METALS**



With an outstanding range of steel products, One Touch Exim Engage in manufacturing and supplying high-quality SS metal products with a robust mix of experience over the decades. Our product range includes various types of steel tubes, tubing & pipes, stainless steel shim, welded pipes, steel pipe fittings, and more.

We have a strict quality control approach to ensure that every product we manufacture and supply must meet industry standards and customer expectations.

We make a global presence with our quality products, commitment & on-time delivery. Our dedicated team of procurement and logistics works 24/7 to support the Marketing team. As a result of buying & selling non-ferrous metal for many years, OneTouchexim has established itself as an outstanding worldwide procurement network, trader & distributor. We manage a huge inventory of metals starting from Stainless Steel, Alloy Steel, Brass & Bronze from the raw material to the finished product.

We offer a platform where small customers can buy a wide range of products with MOQ & we consolidate for them. Our client looking at us as a one-stop solution for all categories of metals. OneTouchexim helps beyond the range on special occasions to find the best match of product. We aim to provide the right product at the right price & the right time.



### **Our Mission**

To manufacture and supply high-quality steel products and services that meet the needs of the customers with minimal environmental impact. Building trust and long-term relationships for achieving goals effectively. We also believe that our success is tied to the success of our employees, stakeholders, & communities.



### **Our Vision**

Expanding global presence through strategic partnerships and acquisitions to better serve customers and create sustainable growth.

We believe that through dedication, hard work, and cooperation we will be able to create a bright future for everyone.

**Accountability**

We have our trusted supply chain to promise delivery on time. We accept our individual and team responsibilities to meet our commitments & take responsibility for our performance in all of our decisions and actions. We take care of accountability for our precious clients doesn't matter when they start working with us.

We have already  
**DELIVERED**  
to more than  
**50** countries

**Positive Change**

Embracing and capitalizing on change, recognizing that every employee must be empowered to stimulate continuous improvement in all aspects of our business. Positive change encourages innovation, develops skills, develops staff and leads to better business opportunities, and improves staff morale.

**Cooperation**

Good mutual cooperation across positions and departments is the basis for a pleasant working atmosphere in which employees feel good about themselves and what they are doing. The outmoded oppositions between production and maintenance, factory and administration, and production and sales no longer have any places.

**Innovation**

We are creative in delivering value to our fellow associates, customers, shareowners, manufacturers, and the community. We anticipate change and capitalize on the many opportunities that arise. Innovation is a continual process that requires ongoing monitoring, testing, and leadership to minimize risks and optimize outcomes.

**Professionalism**

We strive to fulfill our responsibilities to the highest possible standards throughout. Employers want new workers to be responsible, ethical, and team-oriented, and to possess strong communication, interpersonal, and problem-solving skills. Wrap these skills up all together and you've got professionalism.

# 10+ years of experience

**Leadership**

We encourage leadership among employees to develop and maintain a talent pool. Life, Health, and Environment. We seek to improve our well-being, our working conditions, and the surroundings in which we live. This is different from traditional leadership where the leader's main focus is the thriving of their company or organization.

**Teamwork**

A modern company must be based on teamwork and mutual trust, on striving together for continuous improvement. Our team is supportive of each other's efforts, loyal to one another, and cares for each other both personally and professionally. We work together toward a collective goal in an efficient manner.

**Empowerment**

To empower our talented people to take the initiative and to do what's right. Customer service empowerment involves encouraging and authorizing customer service representatives to make decisions that can ultimately benefit both the customer and the company with the help of employee experience.

**Open communication**

All team members are encouraged to openly share their opinions and views. Open communication between senior managers & other workers helps to express their ideas, issues & thoughts with one another in a steady, honest, transparent, and reliable manner. This way, teams can avoid surprises, resolve conflicts, and collaborate better.

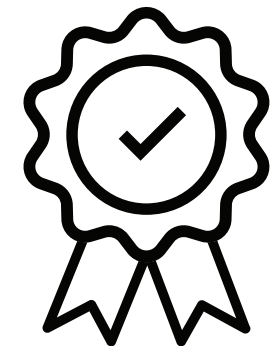

### Coating:

Fitting and accessories are normally internally and externally coated. Normally Bituminous point LP applied. However following coating may also be done.

### External Coating:

- 1- Zinc rich point
- 2- Bituminous point.
- 3- Epoxy powder coating.
- 4- Fusion Bonded Epoxy coating.

### Internal Lining:

Following lining may be applied internally depending on the condition of use.

- 1- Portland cement mortar
- 2- Blast furnacesloy cement mortar.
- 3- High alumina cement mortar
- 4- Bituminous point
- 5- Fusion Bonded epoxy coating

Fittings in the range of DN 80 mm DN 1600 mm in accordance with the following standard:

### Product Range

- ISO 2531/EN 545 for Water
- ISO 7186/EN 598 for Sewerage
- ISO 9523 for Water and Sewerage

### Range of Fittings

- Push on Joints Socket Fittings
- Flanged Fittings
- Loose Flange Fittings
- Mechanical Joints fittings



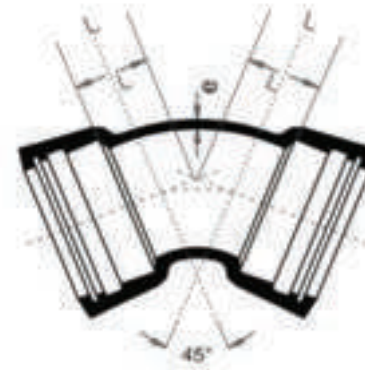
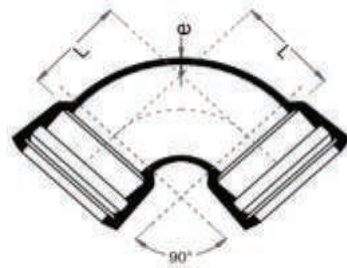

Double Socket Bend 90°	Size/DN	e	L	wt (kg)
	80	7	100	9
	125	7.5	145	15
	150	7.8	170	20
	200	8.4	220	32
	250	9	270	46
	300	9.6	320	66
	350	10.2	370	87
	400	10.8	420	115
	450	11.4	470	150
	500	12	520	185
	600	13.2	620	281
	700	14.4	720	410
	750	15	770	495
	800	15.6	820	550
	900	16.8	920	730
	1000	18	1020	980
1100	19.2	1130	1340	
1200	20.4	1230	1660	
1400	22.8	1430	2430	
1500	24	1530	3000	
1600	25.2	1630	3380	

Double Socket Bend 45°	Size/DN	e	L	wt (kg)
	80	7	55	8
	100	7.2	65	10
	125	7.5	75	13
	150	7.8	85	16
	200	8.4	110	26
	250	9	130	35
	300	9.6	150	49
	350	10.2	175	65
	400	10.8	195	85
	450	11.4	220	106
	500	12	240	130
	600	13.2	285	198
	700	14.4	330	270
	750	15	350	340
	800	15.6	370	370
	900	16.8	415	480
1000	18	460	646	
1100	19.2	505	920	
1200	20.4	550	1120	
1400	22.8	515	1450	
1500	24	540	1750	
1600	25.2	565	1950	

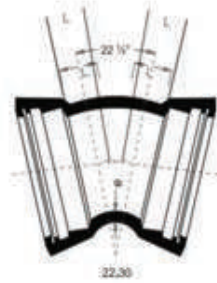

Double Socket Bend 22.5°	Size/DN	e	L	wt(kg)
	80	7	40	7
	100	7.2	40	9
	125	7.5	50	12
	150	7.8	55	15
	200	8.4	65	22
	250	9	75	29
	300	9.6	85	42
	350	10.2	95	54
	400	10.8	110	68
	450	11.4	120	85
	500	12	130	102
	600	13.2	150	158
	700	14.4	175	210
	750	15	185	255
	800	15.6	195	285
	900	16.8	205	365
1000	18	210	480	
1100	19.2	220	660	
1200	20.4	240	760	
1400	22.8	260	1000	
1500	24	270	1350	
1600	25.2	280	1600	

Double Socket Bend 11.25°	Size/DN	e	L	wt(kg)
	80	7	30	7
	100	7.2	30	9
	125	7.5	35	11
	150	7.8	35	14
	200	8.4	40	21
	250	9	50	28
	300	9.6	55	38
	350	10.2	60	47
	400	10.8	65	58
	450	11.4	70	76
	500	12	75	90
	600	13.2	85	132
	700	14.4	95	172
	750	15	100	210
	800	15.6	110	234
	900	16.8	115	300
1000	18	120	380	
1100	19.2	120	530	
1200	20.4	130	600	
1400	22.8	130	820	
1500	24	135	1050	
1600	25.2	140	1250	

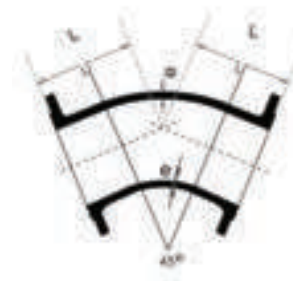
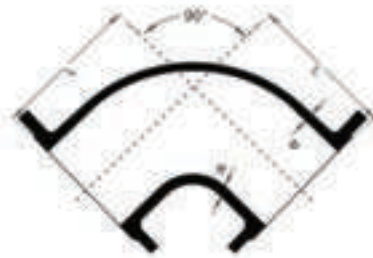

Double Flanged Bend 90°	Size/DN	e	L	wt (kg) PN10	wt(kg) PN16
	80	7	165	10	10
100	7.2	180	12	12	
125	7.5	200	16	16	
150	7.8	220	21	21	
200	8.4	260	31	31	
250	9	350	49	50	
300	9.6	400	68	70	
350	10.2	450	92	97	
400	10.8	500	118	128	
450	11.4	550	146	165	
500	12	600	184	214	
600	13.2	700	277	325	
700	14.4	800	395	420	
750	15	850	470	500	
800	15.6	900	545	575	
900	16.8	1000	710	750	
1000	18	1100	920	992	
1100	19.2	1235	1180	1260	
1200	20.4	1340	1480	1600	
1400	22.8	1550	2150	2280	
1500	24	1660	2650	2800	
1600	25.2	1765	3070	3270	

Double Flanged Bend 45°	Size/DN	e	L	wt (kg) PN10	wt(kg) PN16
	80	7	130	10	10
100	7.2	140	11	11	
125	7.5	150	15	15	
150	7.8	160	19	19	
200	8.4	180	27	27	
250	9	350	54	55	
300	9.6	400	76	78	
350	10.2	289	77	83	
400	10.8	324	98	107	
450	11.4	350	120	140	
500	12	375	148	176	
600	13.2	426	216	263	
700	14.4	478	304	327	
750	15	504	360	385	
800	15.6	529	415	444	
900	16.8	581	530	566	
1000	18	632	685	752	
1100	19.2	694	860	935	
1200	20.4	750	1070	1185	
1400	22.8	775	1435	1550	
1500	24	810	1680	1860	
1600	25.2	845	1970	2150	

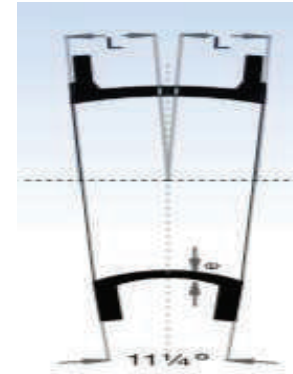
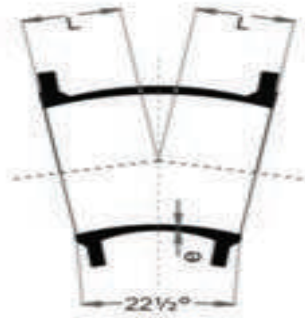

Double Flanged Bend 22.5°	Size/DN	e	L	wt (kg) PN10	wt (kg) PN16
	80	7	85	9	9
	100	7.2	90	10	10
	125	7.5	95	13	13
	150	7.8	105	17	17
	200	8.4	120	24	24
	250	9	135	33	33
	300	9.6	150	45	45
	350	10.2	165	67	72
	400	10.8	175	70	89
	450	11.4	190	84	100
	500	12	205	104	131
	600	13.2	235	152	180
	700	14.4	265	213	237
	750	15	280	249	275
	800	15.6	295	289	319
900	16.8	320	363	401	
1000	18	350	468	538	
1100	19.2	380	583	655	
1200	20.4	410	727	837	
1400	22.8	465	1012	1126	
1500	24	495	1199	1375	
1600	25.2	525	1429	1607	

Double Flanged Bend 11.25°	Size/DN	e	L	wt (kg) PN10	wt (kg) PN16
	80	7	75	8	8
	100	7.2	80	10	10
	125	7.5	85	12	12
	150	7.8	90	16	16
	200	8.4	100	23	23
	250	9	110	31	31
	300	9.6	120	41	41
	350	10.2	130	61	66
	400	10.8	140	63	72
	450	11.4	145	73	89
	500	12	155	90	117
	600	13.2	175	130	158
	700	14.4	195	181	205
	750	15	210	218	244
	800	15.6	215	247	277
900	16.8	235	307	345	
1000	18	255	394	464	
1100	19.2	265	481	551	
1200	20.4	275	582	692	
1400	22.8	295	775	889	
1500	24	330	940	1116	
1600	25.2	370	1158	1336	



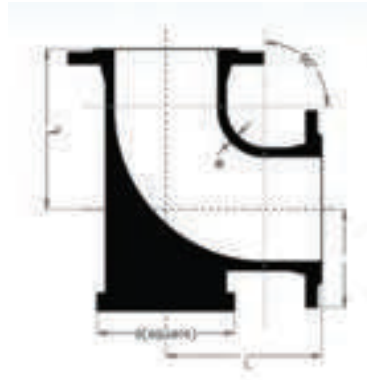

Duckfoot Double Flanged Bend 90°	Size/DN	e	L	H	d	wt(kg) PN10	wt(kg) PN16
	80	7	155	110	180	14	14
100	7.2	175	125	200	18	18	
125	7.5	200	140	225	24	24	
150	7.8	230	160	250	31	31	
200	8.4	280	190	300	47	47	
250	9	335	225	350	76	77	
300	9.6	385	255	400	105	108	
350	10.2	440	290	450	142	147	
400	10.8	495	320	500	192	198	
450	11.4	545	355	550	245	260	
500	12	600	385	600	310	322	
600	13.2	705	450	700	475	495	
700	14.4	810	515	800	585	625	
750	15	860	550	850	700	740	
800	15.6	915	580	900	800	840	
900	16.8	1020	645	1000	1100	1150	
1000	18	1130	710	1100	1400	1480	
1100	19.2	1235	775	1200	1800	1900	
1200	20.4	1340	840	1300	2300	2400	
1400	22.8	1550	970	1500	3300	3420	
1500	24	1660	1035	1600	4100	4240	
1600	25.2	1765	1100	1700	4700	4850	

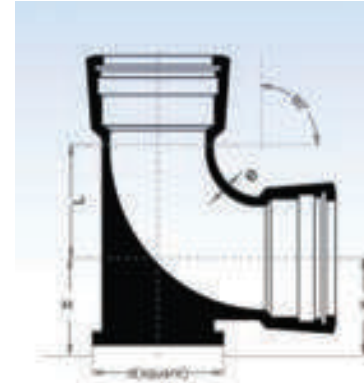

Duckfoot Double Socket Bend 90°	Size/DN	e	L	H	d	wt(kg)
	80	7	110	110	180	13
100	7.2	130	125	200	16	
125	7.5	155	140	225	22	
150	7.8	180	160	250	29	
200	8.4	230	190	300	47	
250	9	280	225	350	70	
300	9.6	325	255	400	100	
350	10.2	380	290	450	135	
400	10.8	430	320	500	180	
450	11.4	480	355	550	230	
500	12	530	385	600	290	
600	13.2	630	450	700	440	
700	14.4	735	515	800	620	
750	15	790	550	850	730	
800	15.6	830	580	900	840	
900	16.8	930	645	1000	1110	
1000	18	1035	710	1100	1460	
1100	19.2	1130	775	1200	1880	
1200	20.4	1230	840	1300	2300	
1400	22.8	1430	970	1500	3590	
1500	24	1530	1035	1600	4400	
1600	25.2	1630	1100	1700	4900	

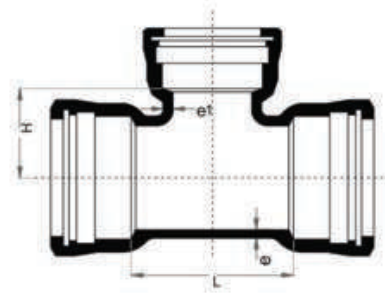

	Size/DN		e	e1	L	H	wt (kg)
	Body	Branch					
All Socket Tee	80	80	7	7	170	85	12
	100	80	7.2	7	170	95	14
	100	100	7.2	7.2	190	95	15
	125	80	7.5	7	170	105	18
	125	100	7.5	7.2	195	100	20
	125	125	7.5	7.5	225	110	22
	150	80	7.8	7	170	120	20
	150	100	7.8	7.2	195	120	22
	150	150	7.8	7.8	255	125	26
	200	80	8.4	7	175	145	29
	200	100	8.4	7.2	200	145	31
	200	150	8.4	7.8	255	150	36
	200	200	8.4	8.4	315	155	40
	250	80	9	7	180	170	37
	250	100	9	7.2	200	170	40
	250	150	9	7.8	260	175	45
	250	200	9	8.4	315	180	50
	250	250	9	9	375	190	57
	300	80	9.6	7	180	235	50
	300	100	9.6	7.2	210	220	51
	300	150	9.6	7.8	260	240	58
	300	200	9.6	8.4	325	220	64
	300	250	9.6	9	380	255	70
	300	300	9.6	9.6	440	220	78
	350	80	10	7	185	260	58
	350	100	10.2	7.2	205	260	59
	350	150	10.2	7.8	265	265	68
	350	200	10.2	8.4	325	270	75
	350	250	10.2	9	380	280	90
	350	300	10.2	9.6	440	285	100
350	350	10.2	10.2	495	290	102	

	Size/DN		e	e1	L	H	wt (kg)
	Body	Branch					
All Socket Tee	400	80	10.8	7	185	285	73
	400	100	10.8	7.2	210	285	72
	400	150	10.8	7.8	270	290	90
	400	200	10.8	8.4	325	295	92
	400	250	10.8	9	385	305	105
	400	300	10.8	9.6	440	310	120
	400	400	10.8	10.8	560	320	130
	450	80	11.4	7	190	310	88
	450	100	11.4	7.2	215	310	90
	450	150	11.4	7.8	270	315	105
	450	200	11.4	8.4	330	320	115
	450	250	11.4	9	390	330	120
	450	300	11.4	9.6	445	335	140
	450	400	11.4	10.8	560	345	165
	450	450	11.4	11.4	620	350	168
	500	80	12	7	195	335	105
	500	100	12	7.2	215	335	107
	500	150	12	7.8	275	340	125
	500	200	12	8.4	330	345	135
	500	250	12	9	390	355	150
	500	300	12	9.6	450	360	160
	500	350	12	10.2	505	365	175
	500	400	12	10.8	565	370	185
	500	500	12	10.12	680	380	205
	600	80	13.2	7	200	385	166
	600	100	13.2	7.2	220	385	168
	600	150	13.2	7.8	280	390	170
	600	200	13.2	8.4	340	395	172
	600	300	13.2	9.6	455	410	210
	600	400	13.2	10.8	570	420	240
600	500	13.2	12	685	430	290	
600	600	13.2	13.2	800	440	300	

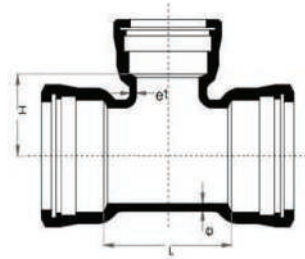

	Size/DN		e	e1	L	H	wt (kg)
	Body	Branch					
All Socket Tee	700	100	14.4	7.2	230	435	205
	700	150	14.4	7.8	285	440	215
	700	200	14.4	8.4	345	445	230
	700	300	14.4	9.6	460	460	270
	700	400	14.4	10.8	557	470	295
	700	500	14.4	12	690	480	370
	700	600	14.4	13.2	810	490	400
	700	700	14.4	14.4	925	500	410
	750	100	15	7.2	230	460	250
	750	150	15	7.8	290	465	265
	750	200	15	8.4	345	470	280
	750	300	15	9.6	465	485	310
	750	400	15	10.8	580	495	340
	750	500	15	12	695	505	390
	750	600	15	13.2	810	515	454
	750	700	15	14.4	925	525	475
	750	750	15	15	985	535	490
	800	100	15.6	7.2	235	485	250
	800	150	15.6	7.8	290	490	265
	800	200	15.6	8.4	350	495	282
	800	300	15.6	9.6	465	510	335
	800	400	15.6	10.8	580	520	370
	800	500	15.6	12	700	530	490
	800	600	15.6	13.2	815	540	525
	800	700	15.6	14.4	930	550	540
	800	800	15.6	15.6	1045	565	570
	900	150	16.8	7.8	300	540	330
	900	200	16.8	8.4	355	545	350
	900	400	16.8	10.8	590	570	445
	900	600	16.8	13.2	820	590	680
	900	800	16.8	15.6	1050	615	720
	900	900	16.8	16.8	1170	625	750

	Size/DN		e	e1	L	H	wt (kg)
	Body	Branch					
All Socket Tee	1000	200	18	7.8	360	595	445
	1000	400	18	8.4	595	620	550
	1000	600	18	10.8	1290	640	880
	1000	800	18	13.2	1290	665	910
	1000	1000	18	15.6	1290	685	950
	1100	200	19.2	7.8	370	645	670
	1100	400	19.2	10.8	600	670	780
	1100	600	19.2	13.2	830	690	910
	1100	800	19.2	15.6	1065	715	1190
	1100	1000	19.2	18	1295	735	1360
	1100	1100	19.2	19.2	1410	745	1460
	1200	200	20.4	8.4	375	695	800
	1200	400	20.4	10.8	605	720	930
	1200	600	20.4	13.2	840	740	1060
	1200	800	20.4	15.6	1070	765	1250
	1200	1000	20.4	18	1300	785	1490
	1200	1200	20.4	20.4	1535	805	1710
	1400	400	22.8	10.8	800	820	1380
	1400	600	22.8	13.2	1030	840	1550
	1400	800	22.8	15.6	1260	865	1750
	1400	1000	22.8	18	1495	885	1960
	1400	1200	22.8	20.4	1725	905	2200
	1400	1400	22.8	22.8	1960	930	2500
	1500	400	24	10.8	805	870	1400
	1500	600	24	13.2	1035	890	1600
	1500	800	24	15.6	1270	915	1850
	1500	1000	24	18	1500	935	2200
	1500	1200	24	20.4	1730	955	2400
	1500	1400	24	22.8	1965	980	2700
	1500	1500	24	24	2080	990	2900
	1600	400	25.2	10.8	810	920	1770
	1600	600	25.2	13.2	1040	940	1980
	1600	800	25.2	15.6	1275	965	2220
1600	1000	25.2	18	1505	985	2460	
1600	1200	25.2	20.4	1740	1005	2800	
1600	1400	25.2	22.8	1970	1030	3000	
1600	1600	25.2	25.2	2200	1050	3400	

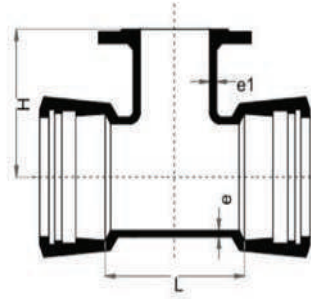

	Size/DN		e	e1	L	H	kg(kg) PN10	wt(kg) PN16
	Body	Branch						
	80	80						
100	80	7.2	7	170	175	15	15	
100	100	7.2	7.2	190	180	16	17	
125	80	7.5	7	170	190	18	18	
125	100	7.5	7.2	195	195	19	20	
125	125	7.5	7.5	225	200	21	22	
150	80	7.8	7	170	205	21	21	
150	100	7.8	7.2	195	210	22	23	
150	150	7.8	7.8	255	220	27	28	
200	80	8.4	7	175	235	29	29	
200	100	8.4	7.2	200	240	31	32	
200	150	8.4	7.8	255	250	36	37	
200	200	8.4	8.4	315	260	42	44	
250	80	9	7	180	265	37	37	
250	100	9	7.2	200	270	38	39	
250	150	9	7.8	260	280	46	49	
250	200	9	8.4	315	290	52	54	
250	250	9	9	375	300	60	62	
300	80	9.6	7	180	295	41	48	
300	100	9.6	7.2	210	300	50	51	
300	150	9.6	7.8	260	310	57	58	
300	200	9.6	8.4	325	320	65	67	
300	250	9.6	9	380	330	74	76	
300	300	9.6	9.6	440	340	80	89	
350	80	10	7	185	325	58	58	
350	100	10.2	7.2	205	330	59	60	
350	150	10.2	7.8	265	340	70	71	
350	200	10.2	8.4	325	350	76	78	
350	250	10.2	9	380	360	90	92	
350	300	10.2	9.6	440	370	110	113	
350	350	10.2	10.2	495	380	114	117	

Double Socket Flange Branch tree

	Size/DN		c	e1	L	H	wt(kg) PN10	wt(kg) PN16
	Body	Branch						
	400	80						
400	100	10.8	7.2	210	360	73	74	
400	150	10.8	7.8	270	370	80	86	
400	200	10.8	8.4	325	380	92	94	
400	250	10.8	9	385	390	103	105	
400	300	10.8	9.6	440	400	114	116	
400	400	10.8	10.8	560	420	145	150	
450	80	11.4	7	190	385	87	87	
450	100	11.4	7.2	215	390	88	89	
450	150	11.4	7.8	270	400	98	98	
450	200	11.4	8.4	330	410	108	110	
450	250	11.4	9	390	420	120	122	
450	300	11.4	9.6	445	430	134	136	
450	400	11.4	10.8	560	450	159	164	
450	450	11.4	11.4	620	460	173	181	
500	80	12	7	195	415	102	102	
500	100	12	7.2	215	420	103	104	
500	150	12	7.8	275	430	123	124	
500	200	12	8.4	330	440	126	128	
500	250	12	9	390	450	150	152	
500	300	12	9.6	450	460	154	156	
500	350	12	10.2	505	470	172	175	
500	400	12	10.8	565	480	181	186	
500	500	12	10.12	680	500	213	227	
600	80	13.2	7	200	475	151	151	
600	100	13.2	7.2	220	480	155	156	
600	150	13.2	7.8	280	490	165	166	
600	200	13.2	8.4	340	500	171	173	
600	300	13.2	9.6	455	520	200	202	
600	400	13.2	10.8	570	540	233	238	
600	500	13.2	12	685	560	290	304	
600	600	13.2	13.2	800	580	320	335	

Double Socket Flange Branch tree

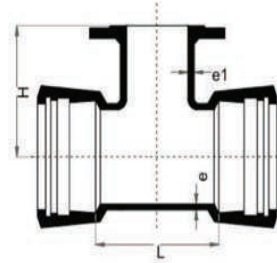

**20 Double Socket Flange Branch tree**

Size/DN	Body	Branch	e	e1	L	H	wt(kg)	
							PN10	PN16
700	100	14.4	7.2	230	510	200	200	
700	150	14.4	7.8	285	520	210	211	
700	200	14.4	8.4	345	525	220	226	
700	300	14.4	9.6	460	540	260	262	
700	400	14.4	10.8	557	555	290	295	
700	500	14.4	12	690	570	350	364	
700	600	14.4	13.2	810	585	385	400	
700	700	14.4	14.4	925	600	425	437	
750	100	15	7.2	230	540	240	240	
750	150	15	7.8	290	550	255	256	
750	200	15	8.4	345	555	270	272	
750	300	15	9.6	465	570	305	307	
750	400	15	10.8	580	585	340	345	
750	500	15	12	695	600	382	396	
750	600	15	13.2	810	615	422	437	
750	700	15	14.4	925	630	465	477	
750	750	15	15	985	640	490	503	
800	100	15.6	7.2	235	570	250	255	
800	150	15.6	7.8	290	580	260	271	
800	200	15.6	8.4	350	585	284	286	
800	300	15.6	9.6	465	600	330	332	
800	400	15.6	12	580	615	365	370	
800	500	15.6	14.4	700	630	500	514	
800	600	15.6	15.6	815	645	535	550	
800	700	15.6	7.8	930	660	550	562	
800	800	15.6	10.8	1045	675	580	595	
900	150	16.8	7.8	300	640	330	331	
900	200	16.8	8.4	355	645	350	352	
900	400	16.8	10.8	590	675	450	455	
900	600	16.8	13.2	820	705	685	700	
900	800	16.8	15.6	1050	735	710	725	
900	900	16.8	16.8	1170	750	755	775	

**20 Double Socket Flange Branch tree**

Size/DN	Body	Branch	e	e1	L	H	wt(kg)	
							PN10	PN16
1000	200	18	8.4	360	705	450	452	
1000	400	18	10.8	595	735	560	565	
1000	600	18	13.2	1290	765	925	942	
1000	800	18	15.6	1290	795	955	970	
1000	1000	18	18	1290	825	985	1020	
1100	200	19.2	8.4	370	765	690	692	
1100	400	19.2	10.8	600	795	785	790	
1100	600	19.2	13.2	830	825	920	935	
1100	800	19.2	15.6	1065	855	1100	1115	
1100	1000	19.2	18	1295	885	1300	1335	
1100	1100	19.2	19.2	1410	900	1415	1410	
1200	200	20.4	8.4	375	825	720	722	
1200	400	20.4	10.8	605	855	895	900	
1200	600	20.4	13.2	840	885	1070	1085	
1200	800	20.4	15.6	1070	915	1240	1255	
1200	1000	20.4	18	1300	945	1440	1475	
1200	1200	20.4	20.4	1535	957	1770	1825	
1400	400	22.8	10.8	800	950	1400	1405	
1400	600	22.8	13.2	1030	980	1565	1580	
1400	800	22.8	15.6	1260	1010	1770	1785	
1400	1000	22.8	18	1495	1040	1985	2020	
1400	1200	22.8	20.4	1725	1070	2320	2375	
1400	1400	22.8	22.8	1960	1100	2630	2690	
1500	400	24	10.8	805	1005	1510	1515	
1500	600	24	13.2	1035	1035	1780	1795	
1500	800	24	15.6	1270	1065	2070	2085	
1500	1000	24	18	1500	1095	2370	2405	
1500	1200	24	20.4	1730	1125	2700	2755	
1500	1400	24	22.8	1965	1155	3040	3100	
1500	1500	24	24	2080	1170	3230	3320	
1600	400	25.2	10.8	810	1060	1780	1785	
1600	600	25.2	13.2	1040	1090	1980	1995	
1600	800	25.2	15.6	1275	1120	2230	2245	
1600	1000	25.2	18	1505	1150	2480	2520	
1600	1200	25.2	20.4	1740	1180	2790	2850	
1600	1400	25.2	22.8	1970	1210	3250	3310	
1600	1600	25.2	25.2	2200	1240	3800	3900	

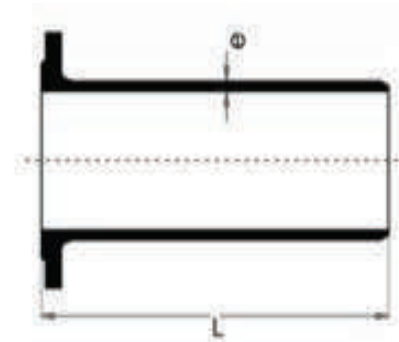
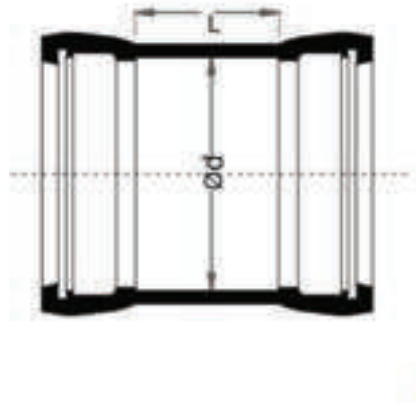

Double Socket Collars	Size/DN	e	L	d	Wt(KG)
	80	7	160	109	9
100	7.2	160	130	10	
125	7.5	165	156	16	
150	7.8	165	183	15	
200	8.4	170	235	22	
250	9	175	288	30	
300	9.6	180	340	38	
350	10.2	185	393	53	
400	10.8	190	455	69	
450	11.4	195	498	81	
500	12	200	550	90	
600	13.2	210	655	115	
700	14.4	220	760	170	
750	15	225	810	190	
800	15.6	230	865	220	
900	16.8	240	970	270	
1000	18	250	1075	340	
1100	19.2	260	1180	420	
1200	20.4	270	1285	490	
1400	22.8	340	1477	670	
1500	24	350	1580	770	
1600	25.2	360	1683	950	

Flange Socket	Size/DN	e	L	WT(Kg) PN10	Wt(kg) PN16
	80	7	130	8	8
100	7.2	130	9	9	
125	7.5	135	12	12	
150	7.8	135	14	14	
200	8.4	140	20	20	
250	9	145	26	28	
300	9.6	150	34	38	
350	10.2	155	44	49	
400	10.8	160	54	62	
450	11.4	165	60	72	
500	12	170	72	90	
600	13.2	180	105	138	
700	14.4	190	148	170	
750	15	195	180	195	
800	15.6	200	195	220	
900	16.8	210	250	275	
1000	18	220	320	357	
1100	19.2	230	420	460	
1200	20.4	240	464	570	
1400	22.8	310	760	770	
1500	24	320	880	910	
1600	25.2	330	1000	1040	

Flange Spigot	Size/DN	e	L	WT(Kg) PN10	Wt(kg) PN16
	80	7	350	8	8
100	7.2	360	10	10	
125	7.5	370	13	13	
150	7.8	380	16	16	
200	8.4	400	23	23	
250	9	420	32	32	
300	9.6	440	41	43	
350	10.2	460	53	56	
400	10.8	480	65	71	
450	11.4	500	80	88	
500	12	520	96	110	
600	13.2	560	136	159	
700	14.4	600	180	197	
750	15	600	210	223	
800	15.6	600	228	249	
900	16.8	600	280	300	
1000	18	600	340	375	
1100	19.2	600	402	437	
1200	20.4	600	470	530	
1400	22.8	710	690	750	
1500	24	745	815	910	
1600	25.2	780	955	1045	

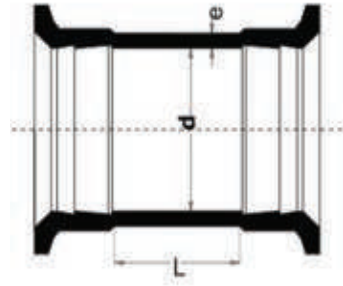

Size/D N	e	L	d	Wt(Kg)
80	7	160	109	9
100	7.2	160	130	11
125	7.5	165	156	17
150	7.8	165	183	18
200	8.4	170	235	23
250	9	175	288	32
300	9.6	180	340	40
350	10.2	185	393	55
400	10.8	190	455	70
450	11.4	195	498	82
500	12	200	550	94
600	13.2	210	655	120
700	14.4	220	760	178
750	15	225	810	198
800	15.6	230	865	225
900	16.8	240	970	272
1000	18	250	1075	343
1100	19.2	260	1180	430
1200	20.4	270	1285	500
1400	22.8	340	1477	680
1500	24	350	1580	780
1600	25.2	360	1683	940

Size/ DN	a		b		D		Wt(kg) PN10	Wt(Kg) PN16
	Blank Flange							
80	19	19	16	16	200	200	4	4
100	19	19	16	16	220	220	5	5
125	19	19	16	16	250	250	6	6
150	19	19	16	16	285	285	8	8
200	20	20	17	17	340	340	11	11
250	22	22	19	19	400	400	17	17
300	24.5	24.5	20.5	20.5	455	455	24	24
350	24.5	24.5	20.5	22.5	505	520	33	37
400	24.5	24.5	20.5	24	565	580	41	49
450	24.5	24.5	21.5	26	615	640	56	64
500	26.5	26.5	22.5	27.5	670	775	65	84
600	30	30	25	31	780	840	94	130
700	32.5	32.5	27.5	34.5	895	910	139	169
750	33	33	28	36	960	970	175	205
800	37.5	37.5	30	38	1015	1025	195	235
900	40	40	32.5	41.5	1115	1125	250	307
1000	42.5	42.5	35	45	1230	1255	330	415
1100	45	45	37.5	48.5	1340	1355	420	520
1200	46	46	40	52	1455	1455	520	660
1400	47.5	47.5	41	55	1675	1685	710	910
1500	49	49	42.5	57.5	1785	1820	830	1100
1600	52	52	44	60	1951	1930	990	1280

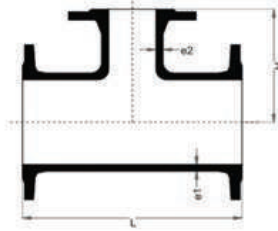

	Size/DN		e	e1	L	H	Wt(kg) PN10	Wt(kg) PN16
	Body	Branch						
All Flange Tee	80	80	7	7	330	165	16	16
	100	80	7.2	7	360	175	18	18
	100	100	7.2	7.2	360	180	19	19
	125	80	7.5	7	400	190	23	23
	125	100	7.5	7.2	400	195	24	24
	125	125	7.5	7.5	400	200	25	25
	150	80	7.8	7	440	205	28	28
	150	100	7.8	7.2	440	210	29	29
	150	150	7.8	7.8	440	215	32	32
	200	80	8.4	7	520	220	41	41
	200	100	8.4	7.2	520	235	42	42
	200	150	8.4	7.8	520	240	45	45
	200	200	8.4	8.4	520	250	49	49
	250	80	9	7	700	235	64	67
	250	100	9	7.2	700	275	65	68
	250	150	9	7.8	700	325	69	71
	250	200	9	8.4	700	325	71	75
	250	250	9	9	700	350	77	81
	300	80	9.6	7	800	265	83	88
	300	100	9.6	7.2	800	300	85	90
	300	150	9.6	7.8	800	350	90	95
	300	200	9.6	8.4	800	350	95	100
	300	250	9.6	9	800	350	103	108
	300	300	9.6	9.6	800	400	110	115
	350	80	10	7	850	295	107	115
	350	100	10.2	7.2	850	325	110	118
	350	150	10.2	7.8	850	325	113	122
	350	200	10.2	8.4	850	325	116	125
	350	250	10.2	9	850	325	133	138
	350	300	10.2	9.6	850	425	137	144
	350	350	10.2	10.2	850	425	140	150

	Size/DN		e	e1	L	H	Wt(kg) PN10	Wt(kg) PN16
	Body	Branch						
All Flange Tee	400	80	10.8	7	900	325	135	145
	400	100	10.8	7.2	900	350	140	150
	400	150	10.8	7.8	900	350	149	158
	400	200	10.8	8.4	900	350	145	155
	400	250	10.8	9	900	350	152	163
	400	300	10.8	9.6	900	450	158	170
	400	400	10.8	10.8	900	450	170	185
	450	80	11.4	7	950	355	160	180
	450	100	11.4	7.2	950	375	166	185
	450	150	11.4	7.8	950	375	168	188
	450	200	11.4	8.4	950	375	170	190
	450	250	11.4	9	950	375	177	197
	450	300	11.4	9.6	950	475	184	204
	450	400	11.4	10.8	950	475	196	216
	450	450	11.4	11.4	950	475	201	230
	500	80	12	7	1000	385	208	238
	500	100	12	7.2	1000	400	210	240
	500	150	12	7.8	1000	400	213	243
	500	200	12	8.4	1000	400	215	245
	500	250	12	9	1000	400	220	250
	500	300	12	9.6	1000	500	230	260
	500	350	12	10.2	1000	500	240	270
	500	400	12	10.8	1000	500	250	280
	500	500	12	10.12	1000	500	270	300
	600	80	13.2	7	1100	445	290	340
	600	100	13.2	7.2	1100	450	292	342
	600	150	13.2	7.8	1100	450	295	345
	600	200	13.2	8.4	1100	450	300	355
	600	300	13.2	9.6	1100	550	315	370
	600	400	13.2	10.8	1100	550	330	390
	600	500	13.2	12	1100	550	350	420
	600	600	13.2	13.2	1100	550	370	440



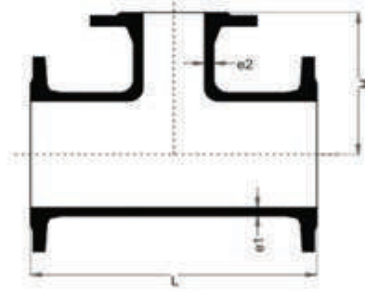

	Size/DN		e	e1	L	H	Wt(kg) PN10	Wt(kg) PN16
	Body	Branch						
All Flange Tee	700	100	14.4	7.2	540	510	245	270
	700	150	14.4	7.8	600	520	265	290
	700	200	14.4	8.4	650	525	280	305
	700	300	14.4	9.6	760	540	315	340
	700	400	14.4	10.8	870	55	350	375
	700	500	14.4	12	1000	570	405	435
	700	600	14.4	13.2	1200	585	475	515
	700	700	14.4	14.4	1200	600	505	545
	750	100	15	7.2	550	540	270	300
	750	150	15	7.8	610	550	280	310
	750	200	15	8.4	670	555	287	317
	750	300	15	9.6	780	570	349	384
	750	400	15	10.8	890	585	359	394
	750	500	15	12	1020	600	485	530
	750	600	15	13.2	1130	615	500	545
	750	700	15	14.4	1250	630	515	560
	750	750	15	15	1275	640	525	570
	800	100	15.6	7.2	560	570	350	375
	800	150	15.6	7.8	620	580	355	380
	800	200	15.6	8.4	690	585	360	385
	800	300	15.6	9.6	800	600	413	443
	800	400	15.6	10.8	910	0.615	440	480
	800	500	15.6	12	1030	630	546	590
	800	600	15.6	13.2	1350	645	610	650
	800	700	15.6	14.4	1350	660	659	709
	800	800	15.6	15.6	1350	675	660	700
	900	150	16.8	7.8	650	640	390	430
	900	200	16.8	8.4	730	645	400	440
	900	400	16.8	10.8	950	675	510	560
	900	600	16.8	13.2	1500	705	730	800
900	800	16.8	15.6	1500	735	830	890	
900	900	16.8	16.8	1500	750	840	900	

	Size/DN		e	e1	L	H	Wt(kg) PN10	Wt(kg) PN16
	Body	Branch						
All Flange Tee	1000	150	18	7.8	720	700	505	565
	1000	200	18	8.4	770	705	510	570
	1000	400	18	10.8	990	735	670	730
	1000	600	18	13.2	1650	765	970	1050
	1000	800	18	15.6	1650	795	1050	1130
	1000	1000	18	18	1650	825	1100	1200
	1100	200	19.2	8.4	760	765	650	720
	1100	400	19.2	10.8	980	795	770	860
	1100	600	19.2	13.2	1210	825	940	1030
	1100	800	19.2	15.6	1470	855	1140	1225
	1100	1000	19.2	18	1690	885	1345	1450
	1100	1100	19.2	19.2	1800	900	1450	1555
	1200	200	20.4	8.4	780	825	800	900
	1200	400	20.4	10.8	1070	855	990	1110
	1200	600	20.4	13.2	1240	885	1100	1220
	1200	800	20.4	15.6	1470	915	1300	1420
	1200	1000	20.4	18	1700	945	1500	1650
	1200	1200	20.4	20.4	1950	975	1790	1950
	1400	400	22.8	10.8	1050	950	1240	1380
	1400	600	22.8	13.2	1550	980	1527	1665
	1400	800	22.8	15.6	1760	1010	1755	1884
	1400	1000	22.8	18	2015	1040	1995	2143
	1400	1200	22.8	20.4	2015	1070	2262	2431
	1400	1400	22.8	22.8	2200	1100	2545	2715
	1500	400	24	10.8	1070	1005	1525	1730
	1500	600	24	13.2	1350	1035	1700	1900
	1500	800	24	15.6	1570	1065	1900	2100
	1500	1000	24	18	1790	1095	2200	2400
	1500	1200	24	20.4	2010	1125	2500	2700
	1500	1400	24	22.8	2230	1155	2750	2980
	1500	1500	24	24	2340	1170	2900	3130
	1600	400	25.2	10.8	1100	1060	1700	1900
	1600	600	25.2	13.2	1600	1090	2000	2200
	1600	800	25.2	15.6	1835	1120	2300	2500
	1600	1000	25.2	18	2065	1150	2500	2700
	1600	1200	25.2	20.4	2300	1180	2800	3000
	1600	1400	25.2	22.8	2300	1210	3208	3444
	1600	1600	25.2	25.2	2480	1240	3586	3854

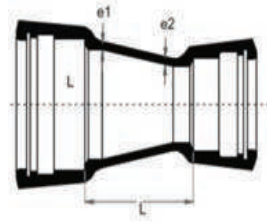

Double Socket Reducer	Size/DN		e	e1	L	Wt(kg)
	Larger end	Smaller end				
	100	80	7.2	7	90	8
	125	80	7.5	7	140	11
	125	100	7.5	7.2	100	11
	150	80	7.8	7	190	13
	150	100	7.8	7.2	150	14
	150	125	7.8	7.5	100	14
	200	80	8.4	7.2	250	
	200	100	8.4	7.5	200	20
	200	125	8.4	7.8	150	21
	200	150	8.4	7.5	300	22
	250	125	9	7.8	250	28
	250	150	9	8.4	150	30
	250	200	9	7.8	350	28
	300	150	9.6	8.4	250	39
	300	200	9.6	9	150	39
	300	250	9.6	8.4	360	36
	350	200	10.2	9	260	52
	350	250	10.2	8.4	360	51
	350	300	10.2	9	150	50
	400	200	10.8	8.4	360	68
	400	250	10.8	9	360	62
	400	300	10.8	9.6	260	60
	400	350	10.8	10.2	160	54
	450	250	11.4	9	260	72
	450	300	11.4	9.6	260	74
	450	350	11.4	10.2	260	72
	450	400	11.4	10.8	160	68
	500	300	12	9.6	360	94
	500	350	12	10.2	360	95
	500	400	12	10.8	260	90
	500	450	12	11.4	160	85
	600	350	13.2	10.2	460	138
	600	400	13.2	10.8	460	140
	600	450	13.2	11.4	360	136
	600	500	13.2	12	260	124

Double Socket Reducer	Size/DN		e	e1	L	Wt(kg)
	Larger end	Smaller end				
	700	400	14.4	10.8	480	184
	700	450	14.4	11.4	480	188
	700	500	14.4	12	480	192
	700	600	14.4	13.2	280	174
	750	450	15	11.4	480	210
	750	500	15	12	480	215
	750	600	15	13.2	280	200
	750	700	15	14.4	180	185
	800	450	15.6	11.4	480	246
	800	500	15.6	12	480	248
	800	600	15.6	13.2	480	248
	800	700	15.6	14.4	280	224
	900	500	16.8	12	480	312
	900	600	16.8	13.2	480	315
	900	700	16.8	14.4	480	318
	900	800	16.8	15.6	280	288
	1000	600	18	13.2	480	380
	1000	700	18	14.4	480	385
	1000	800	18	15.6	480	390
	1000	900	18	16.8	280	360
	1100	700	19.2	14.4	480	560
	1100	800	19.2	15.6	480	570
	1100	900	19.2	16.8	480	580
	1100	1000	19.2	18	280	500
	1200	700	20.4	14.4	480	630
	1200	800	20.4	15.6	480	640
	1200	900	20.4	16.8	480	650
	1200	1000	20.4	18	480	660
	1200	1100	20.4	19.2	280	610
	1400	800	22.8	15.6	360	780
	1400	900	22.8	16.8	360	810
	1400	1000	22.8	18	360	840
	1400	1100	22.8	19.2	360	880
	1400	1200	22.8	20.4	360	900
	1500	900	24	22.8	360	990
	1500	1000	24	18	360	1010
	1500	1100	24	19.2	360	1030
	1500	1200	24	20.4	260	1010
	1500	1400	24	22.8	260	1040
	1600	1000	25.2	18	360	1070
	1600	1100	25.2	19.2	360	1100
	1600	1200	25.2	20.4	360	1120

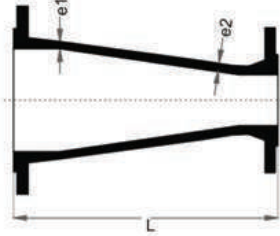

Double Flange Reducer	Size/DN		e	e1	L	Wt(Kg) PN10	WT(KG) PN16
	Larger end	Smaller end					
	100	80	7.2	7	200	10	10
	125	80	7.5	7	200	14	14
	125	100	7.5	7.2	200	15	15
	150	80	7.8	7	200	17	17
	150	100	7.8	7.2	200	18	18
	150	125	7.8	7.5	200	19	19
	200	100	8.4	7.2	300	20	20
	200	125	8.4	7.5	300	21	21
	200	150	8.4	7.8	300	22	22
	250	125	9	7.5	300	30	30
	250	150	9	7.8	300	30	30
	250	200	9	8.4	300	31	31
	300	150	9.6	7.8	300	36	38
	300	200	9.6	8.4	300	38	40
	300	250	9.6	9	300	40	42
	350	200	10.2	8.4	300	48	51
	350	250	10.2	9	300	49	52
	350	300	10.2	9.6	300	50	53
	400	200	10.8	8.4	300	57	65
	400	250	10.8	9	300	58	66
	400	300	10.8	9.6	300	59	67
	400	350	10.8	10.2	300	60	68
	450	250	11.4	9	300	68	81
	450	300	11.4	9.6	300	69	82
	450	350	11.4	10.2	300	70	83
	450	400	11.4	10.8	300	71	84
	500	300	12	9.6	600	110	128
	500	350	12	10.2	600	111	130
	500	400	12	10.8	600	113	133
	500	450	12	11.4	600	116	144
	600	350	13.2	10.2	600	148	182
	600	400	13.2	10.8	600	150	185
	600	450	13.2	11.4	600	152	189
	600	500	13.2	12	600	154	193
	700	400	14.4	10.8	600	197	226
	700	450	14.4	11.4	600	198	230
	700	500	14.4	12	600	200	235

	Size/DN		e	e1	L	Wt(Kg) PN10	WT(KG) PN16
	Larger end	Smaller end					
	700	600	14.4	13.2	600	204	241
	750	450	15	11.4	600	213	250
	750	500	15	12	600	215	255
	750	600	15	13.2	600	220	260
	750	700	15	14.4	600	234	270
	800	450	15.6	11.4	600	254	280
	800	500	15.6	12	600	256	284
	800	600	15.6	13.2	600	260	288
	800	700	15.6	14.4	600	263	292
	900	500	16.8	12	600	310	345
	900	600	16.8	13.2	600	315	348
	900	700	16.8	14.4	600	320	352
	900	800	16.8	15.6	600	325	360
	1000	600	18	13.2	600	380	420
	1000	700	18	14.4	600	385	425
	1000	800	18	15.6	600	390	435
	1000	900	18	16.8	600	393	450
	1100	700	19.2	14.4	600	455	515
	1100	800	19.2	15.6	600	460	525
	1100	900	19.2	16.8	600	465	540
	1100	1000	19.2	18	600	474	550
	1200	700	20.4	14.4	790	716	685
	1200	800	20.4	15.6	790	720	695
	1200	900	20.4	16.8	790	726	700
	1200	1000	20.4	18	790	737	710
	1200	1100	20.4	19.2	790	768	740
	1400	800	22.8	15.6	850	990	930
	1400	900	22.8	16.8	850	996	935
	1400	1000	22.8	18	850	1008	950
	1400	1100	22.8	19.2	850	1020	960
	1400	1200	22.8	20.4	850	1031	980
	1500	900	24	22.8	910	1320	1215
	1500	1000	24	18	910	1332	1230
	1500	1100	24	19.2	910	1344	1250
	1500	1200	24	20.4	910	1356	1270
	1500	1400	24	22.8	910	1374	1290
	1600	1000	25.2	18	910	1356	1265
	1600	1100	25.2	19.2	910	1368	1275
	1600	1200	25.2	20.4	910	1380	1295
	1600	1400	25.2	22.8	910	1398	1311
	1600	1500	25.2	24	910	1440	1380

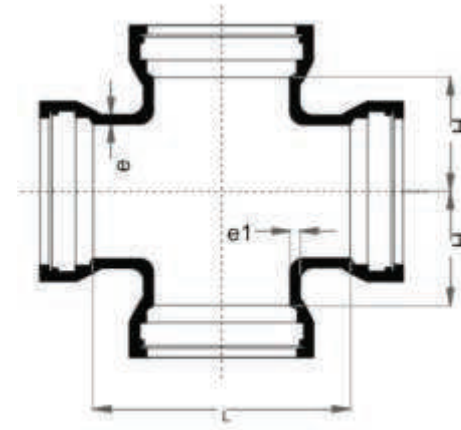
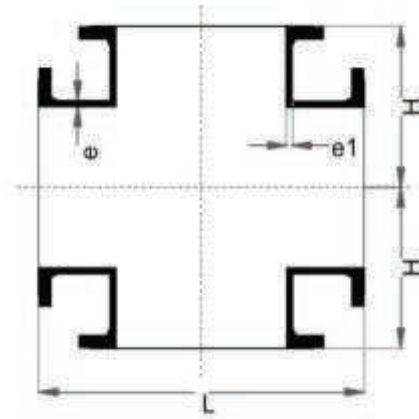

	Size/DN		e	L	H	Wt(kg) PN10	Wt(kg) PN16
	DN	dn					
All Flange Cross	80	80	7	330	165	22	22
	100	100	7.2	360	180	26	26
	150	150	7.8	440	220	42	42
	200	200	8.4	520	260	66	66
	250	250	9	700	350	98	108
	300	300	9.6	800	400	143	150
	350	350	10.2	850	425	189	200
	400	400	10.8	900	450	236	247
	450	450	11.4	950	475	386	307
	500	500	12	1000	500	370	400
	600	600	13.2	1100	550	542	525
	700	700	14.4	1200	600	730	790
	750	750	15	1275	640	760	830
	800	800	15.6	1350	675	960	1015
	900	900	16.8	1500	750	1220	1305
	1000	1000	18	1650	825	1600	1750

	Size/DN		e	L	H	Wt(kg)
	DN	dn				
All Socket Cross	80	80	7	170	85	16
	100	100	7.2	190	95	20
	150	150	7.8	255	125	34
	200	200	8.4	315	155	52
	250	250	9	375	190	76
	300	300	9.6	440	220	104
	350	350	10.2	500	250	136
	400	400	10.8	560	280	172
	450	450	11.4	620	310	224
	500	500	12	680	340	272
	600	600	13.2	800	400	400
	700	700	14.4	925	460	545
	750	750	15	985	490	650
	800	800	15.6	1045	520	760
	900	900	16.8	1170	585	1000
	1000	1000	18	1290	645	1280

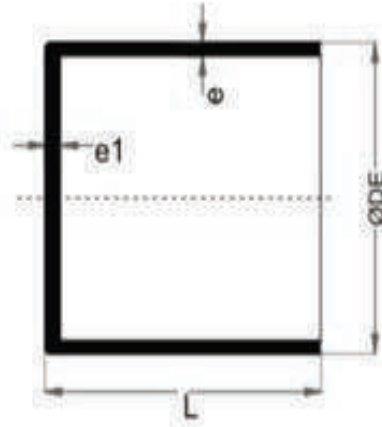
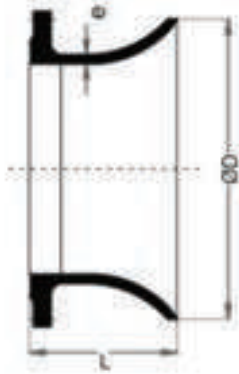

Size/DN	D	L	Wt(kg) PN10	Wt(kg) PN16
80	150	130	6	6
100	175	135	7	7
125	230	150	10	11
150	290	170	15	15
200	345	185	20	21
250	405	205	29	30
300	460	220	36	38
350	520	240	45	50
400	575	255	54	62
450	635	275	67	80
500	7560	310	97	120
600	865	345	135	146
700	925	360	160	172
750	980	380	182	197
800	1095	415	231	250
900	1210	450	297	331
1000	1325	485	370	405
1100	1140	520	457	512
1200	1670	590	646	702
1400	1785	625	763	851
1500	1900	660	906	995
1600	2130	730	1185	1297

Plugs	Size/DN	e	e1	L	Wt (KG)
	80	7	9.5	113	3
	100	7.2	10.5	120	5
	150	7.8	12.5	130	9
	200	8.4	13.5	146	13
	250	9	14.5	152	18
	300	9.6	15.5	159	31
	350	10.2	16.5	176	42
	400	10.8	17.5	178	50
	450	11.4	19	180	65
	500	12	20	187	82
	600	13.2	21	194	122
	700	14.4	23	200	175

EndCap	Size/DN	e	e1	L	Wt(kg)
	80	7	9.5	80	4
	100	7.2	10.5	80	5
	150	7.8	12.5	90	9
	200	8.4	13.5	90	16
	250	9	14.5	90	19
	300	9.6	15.5	110	30
	350	10.2	16.5	110	46
	400	10.8	17.5	110	60
	450	11.4	19	110	76
	500	12	20	110	91
	600	13.2	21	110	127
	700	14.4	23	120	175

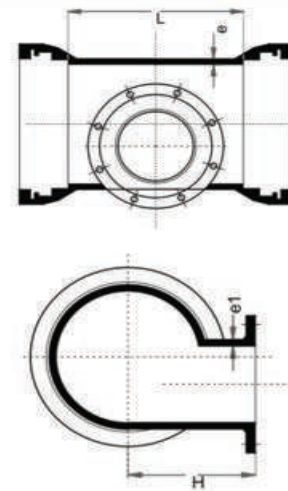

Size/DN	Body Branch		e	e1	L	H	wt(kg) PN10	wt(kg) PN16
	Body	Branch						
80	80	7	7	170	165	13	13	
100	80	7.2	7	170	175	15	15	
100	100	7.2	7.2	190	180	16	17	
125	80	7.5	7	170	190	18	18	
125	100	7.5	7.2	195	195	19	20	
125	125	7.5	7.5	225	200	21	22	
150	80	7.8	7	170	205	21	21	
150	100	7.8	7.2	195	210	22	23	
150	150	7.8	7.8	255	220	27	28	
200	80	8.4	7	175	235	29	29	
200	100	8.4	7.2	200	240	31	32	
200	150	8.4	7.8	255	250	36	37	
200	200	8.4	8.4	315	260	42	44	
250	80	9	7	180	265	37	37	
250	100	9	7.2	200	270	38	39	
250	150	9	7.8	260	280	46	49	
250	200	9	8.4	315	290	52	54	
250	250	9	9	375	300	60	62	
300	80	9.6	7	180	295	41	48	
300	100	9.6	7.2	210	300	50	51	
300	150	9.6	7.8	260	310	57	58	
300	200	9.6	8.4	325	320	65	67	
300	250	9.6	9	380	330	74	76	
300	300	9.6	9.6	440	340	80	89	
350	80	10	7	185	325	58	58	
350	100	10.2	7.2	205	330	59	60	
350	150	10.2	7.8	265	340	70	71	
350	200	10.2	8.4	325	350	76	78	
350	250	10.2	9	380	360	90	92	
350	300	10.2	9.6	440	370	110	113	
350	350	10.2	10.2	495	380	114	117	

Double Socket Leavel Invert Tee With Flange Branch

Size/DN	Body Branch		e	e1	L	H	wt(kg) PN10	wt(kg) PN16
	Body	Branch						
400	80	10.8	7	185	355	70	70	
400	100	10.8	7.2	210	360	73	74	
400	150	10.8	7.8	270	370	80	86	
400	200	10.8	8.4	325	380	92	94	
400	250	10.8	9	385	390	103	105	
400	300	10.8	9.6	440	400	114	116	
400	400	10.8	10.8	560	420	145	150	
450	80	11.4	7	190	385	87	87	
450	100	11.4	7.2	215	390	88	89	
450	150	11.4	7.8	270	400	98	98	
450	200	11.4	8.4	330	410	108	110	
450	250	11.4	9	390	420	120	122	
450	300	11.4	9.6	445	430	134	136	
450	400	11.4	10.8	560	450	159	164	
450	450	11.4	11.4	620	460	173	181	
500	80	12	7	195	415	102	102	
500	100	12	7.2	215	420	103	104	
500	150	12	7.8	275	430	123	124	
500	200	12	8.4	330	440	126	128	
500	250	12	9	390	450	150	152	
500	300	12	9.6	450	460	154	156	
500	350	12	10.2	505	470	172	175	
500	400	12	10.8	565	480	181	186	
500	500	12	10.12	680	500	213	227	
600	80	13.2	7	200	475	151	151	
600	100	13.2	7.2	220	480	155	156	
600	150	13.2	7.8	280	490	165	166	
600	200	13.2	8.4	340	500	171	173	
600	300	13.2	9.6	455	520	200	202	
600	400	13.2	10.8	570	540	233	238	
600	500	13.2	12	685	560	290	304	
600	600	13.2	13.2	800	580	320	335	

Double Socket Leavel Invert Tee With Flange Branch

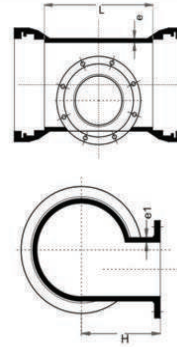

	Size/DN		e	e1	L	H	wt(kg wt(kg))	
	Body	Branch					pn10	pn16
	Double socket Level Invert Tee With Flange Branch	700	100	14.4	7.2	230	510	200
700		150	14.4	7.8	285	520	210	211
700		200	14.4	8.4	345	525	220	226
700		300	14.4	9.6	460	540	260	262
700		400	14.4	10.8	557	555	290	295
700		500	14.4	12	690	570	350	364
700		600	14.4	13.2	810	585	385	400
700		700	14.4	14.4	925	600	425	437
750		100	15	7.2	230	540	240	240
750		150	15	7.8	290	550	255	256
750		200	15	8.4	345	555	270	272
750		300	15	9.6	465	570	305	307
750		400	15	10.8	580	585	340	345
750		500	15	12	695	600	382	396
750		600	15	13.2	810	615	422	437
750		700	15	14.4	925	630	465	477
750		750	15	15	985	640	490	503
800		100	15.6	7.2	235	570	250	255
800		150	15.6	7.8	290	580	260	271
800		200	15.6	8.4	350	585	284	286
800		300	15.6	9.6	465	600	330	332
800		400	15.6	12	580	615	365	370
800		500	15.6	14.4	700	630	500	514
800		600	15.6	15.6	815	645	535	550
800	700	15.6	7.8	930	660	550	562	
800	800	15.6	10.8	1045	675	580	595	
900	150	16.8	7.8	300	640	330	331	
900	200	16.8	8.4	355	645	350	352	
900	400	16.8	10.8	590	675	450	455	
900	600	16.8	13.2	820	705	685	700	
900	800	16.8	15.6	1050	735	710	725	
900	900	16.8	16.8	1170	750	755	775	

	Size/DN		e	e1	L	H	wt(kg wt(kg))	
	Body	Branch					pn10	pn16
	Double socket Level Invert Tee With Flange Branch	1000	200	18	8.4	360	705	450
1000		400	18	10.8	595	735	560	565
1000		600	18	13.2	1290	765	925	942
1000		800	18	15.6	1290	795	955	970
1000		1000	18	18	1290	825	985	1020
1100		200	19.2	8.4	370	765	690	692
1100		400	19.2	10.8	600	795	785	790
1100		600	19.2	13.2	830	825	920	935
1100		800	19.2	15.6	1065	855	1100	1115
1100		1000	19.2	18	1295	885	1300	1335
1100		1100	19.2	19.2	1410	900	1415	1410
1200		200	20.4	8.4	375	825	720	722
1200		400	20.4	10.8	605	855	895	900
1200		600	20.4	13.2	840	885	1070	1085
1200		800	20.4	15.6	1070	915	1240	1255
1200		1000	20.4	18	1300	945	1440	1475
1200		1200	20.4	20.4	1535	957	1770	1825
1400		400	22.8	10.8	800	950	1400	1405
1400		600	22.8	13.2	1030	980	1565	1580
1400		800	22.8	15.6	1260	1010	1770	1785
1400		1000	22.8	18	1495	1040	1985	2020
1400		1200	22.8	20.4	1725	1070	2320	2375
1400		1400	22.8	22.8	1960	1100	2630	2690
1500		400	24	10.8	805	1005	1510	1515
1500		600	24	13.2	1035	1035	1780	1795
1500		800	24	15.6	1270	1065	2070	2085
1500		1000	24	18	1500	1095	2370	2405
1500		1200	24	20.4	1730	1125	2700	2755
1500		1400	24	22.8	1965	1155	3040	3100
1500		1500	24	24	2080	1170	3230	3320
1600		400	25.2	10.8	810	1060	1780	1785
1600		600	25.2	13.2	1040	1090	1980	1995
1600		800	25.2	15.6	1275	1120	2230	2245
1600		1000	25.2	18	1505	1150	2480	2520
1600		1200	25.2	20.4	1740	1180	2790	2850
1600		1400	25.2	22.8	1970	1210	3250	3310
1600	1600	25.2	25.2	2200	1240	3800	3900	

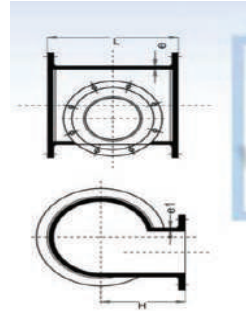

	Size/DN		e	e1	L	H	Wt(kg)Wt(kg)	
	Body	Branch					PN10	PN16
	All Flange Level Invert Tee							
80	80	7	7	330	165	16	16	
100	80	7.2	7	360	175	18	18	
100	100	7.2	7.2	360	180	19	19	
125	80	7.5	7	400	190	23	23	
125	100	7.5	7.2	400	195	24	24	
125	125	7.5	7.5	400	200	25	25	
150	80	7.8	7	440	205	28	28	
150	100	7.8	7.2	440	210	29	29	
150	150	7.8	7.8	440	215	32	32	
200	80	8.4	7	520	220	41	41	
200	100	8.4	7.2	520	235	42	42	
200	150	8.4	7.8	520	240	45	45	
200	200	8.4	8.4	520	250	49	49	
250	80	9	7	700	235	64	67	
250	100	9	7.2	700	275	65	68	
250	150	9	7.8	700	325	69	71	
250	200	9	8.4	700	325	71	75	
250	250	9	9	700	350	77	81	
300	80	9.6	7	800	265	83	88	
300	100	9.6	7.2	800	300	85	90	
300	150	9.6	7.8	800	350	90	95	
300	200	9.6	8.4	800	350	95	100	
300	250	9.6	9	800	350	103	108	
300	300	9.6	9.6	800	400	110	115	
350	80	10	7	850	295	107	115	
350	100	10.2	7.2	850	325	110	118	
350	150	10.2	7.8	850	325	113	122	
350	200	10.2	8.4	850	325	116	125	
350	250	10.2	9	850	325	133	138	
350	300	10.2	9.6	850	425	137	144	
350	350	10.2	10.2	850	425	140	150	

	Size/DN		e	e1	L	H	Wt(kg) Wt(kg)	
	Body	Branch					PN10	PN16
	All Flange Level Invert Tee							
400	80	10.8	7	900	325	135	145	
400	100	10.8	7.2	900	350	140	150	
400	150	10.8	7.8	900	350	149	158	
400	200	10.8	8.4	900	350	145	155	
400	250	10.8	9	900	350	152	163	
400	300	10.8	9.6	900	450	158	170	
400	400	10.8	10.8	900	450	170	185	
450	80	11.4	7	950	355	160	180	
450	100	11.4	7.2	950	375	166	185	
450	150	11.4	7.8	950	375	168	188	
450	200	11.4	8.4	950	375	170	190	
450	250	11.4	9	950	375	177	197	
450	300	11.4	9.6	950	475	184	204	
450	400	11.4	10.8	950	475	196	216	
450	450	11.4	11.4	950	475	201	230	
500	80	12	7	1000	385	208	238	
500	100	12	7.2	1000	400	210	240	
500	150	12	7.8	1000	400	213	243	
500	200	12	8.4	1000	400	215	245	
500	250	12	9	1000	400	220	250	
500	300	12	9.6	1000	500	230	260	
500	350	12	10.2	1000	500	240	270	
500	400	12	10.8	1000	500	250	280	
500	500	12	10.12	1000	500	270	300	
600	80	13.2	7	1100	445	290	340	
600	100	13.2	7.2	1100	450	292	342	
600	150	13.2	7.8	1100	450	295	345	
600	200	13.2	8.4	1100	450	300	355	
600	300	13.2	9.6	1100	550	315	370	
600	400	13.2	10.8	1100	550	330	390	
600	500	13.2	12	1100	550	350	420	
600	600	13.2	13.2	1100	550	370	440	



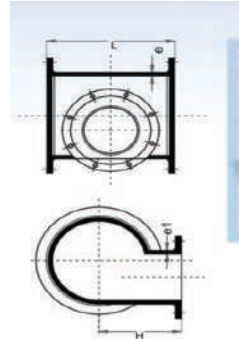

	Size/DN		e	e1	L	H	Wt(kg)	
	Body	Branch					PN10	PN16
	All FlangeLevel Invert Tee	700	100	14.4	7.2	540	510	245
700		150	14.4	7.8	600	520	265	290
700		200	14.4	8.4	650	525	280	305
700		300	14.4	9.6	760	540	315	340
700		400	14.4	10.8	870	55	350	375
700		500	14.4	12	1000	570	405	435
700		600	14.4	13.2	1200	585	475	515
700		700	14.4	14.4	1200	600	505	545
750		100	15	7.2	550	540	270	300
750		150	15	7.8	610	550	280	310
750		200	15	8.4	670	555	287	317
750		300	15	9.6	780	570	349	384
750		400	15	10.8	890	585	359	394
750		500	15	12	1020	600	485	530
750		600	15	13.2	1130	615	500	545
750		700	15	14.4	1250	630	515	560
750		750	15	15	1275	640	525	570
800		100	15.6	7.2	560	570	350	375
800		150	15.6	7.8	620	580	355	380
800		200	15.6	8.4	690	585	360	385
800		300	15.6	9.6	800	600	413	443
800		400	15.6	10.8	910	0.615	440	480
800		500	15.6	12	1030	630	546	590
800		600	15.6	13.2	1350	645	610	650
800		700	15.6	14.4	1350	660	659	709
800		800	15.6	15.6	1350	675	660	700
900		150	16.8	7.8	650	640	390	430
900		200	16.8	8.4	730	645	400	440
900		400	16.8	10.8	950	675	510	560
900		600	16.8	13.2	1500	705	730	800
900	800	16.8	15.6	1500	735	830	890	
900	900	16.8	16.8	1500	750	840	900	

	Size/DN		e	e1	L	H	Wt(kg)	
	Body	Branch					PN10	PN16
	All FlangeLevel Invert Tee	1000	150	18	7.8	720	700	505
1000		200	18	8.4	770	705	510	570
1000		400	18	10.8	990	735	670	730
1000		600	18	13.2	1650	765	970	1050
1000		800	18	15.6	1650	795	1050	1130
1000		1000	18	18	1650	825	1100	1200
1100		200	19.2	8.4	760	765	650	720
1100		400	19.2	10.8	980	795	770	860
1100		600	19.2	13.2	1210	825	940	1030
1100		800	19.2	15.6	1470	855	1140	1225
1100		1000	19.2	18	1690	885	1345	1450
1100		1100	19.2	19.2	1800	900	1450	1555
1200		200	20.4	8.4	780	825	800	900
1200		400	20.4	10.8	1070	855	990	1110
1200		600	20.4	13.2	1240	885	1100	1220
1200		800	20.4	15.6	1470	915	1300	1420
1200		1000	20.4	18	1700	945	1500	1650
1200		1200	20.4	20.4	1950	975	1790	1950
1400		400	22.8	10.8	1050	950	1240	1380
1400		600	22.8	13.2	1550	980	1527	1665
1400		800	22.8	15.6	1760	1010	1755	1884
1400		1000	22.8	18	2015	1040	1995	2143
1400		1200	22.8	20.4	2015	1070	2262	2431
1400		1400	22.8	22.8	2200	1100	2545	2715
1500		400	24	10.8	1070	1005	1525	1730
1500		600	24	13.2	1350	1035	1700	1900
1500		800	24	15.6	1570	1065	1900	2100
1500		1000	24	18	1790	1095	2200	2400
1500		1200	24	20.4	2010	1125	2500	2700
1500		1400	24	22.8	2230	1155	2750	2980
1500	1500	24	24	2340	1170	2900	3130	
1600	400	25.2	10.8	1100	1060	1700	1900	
1600	600	25.2	13.2	1600	1090	2000	2200	
1600	800	25.2	15.6	1835	1120	2300	2500	
1600	1000	25.2	18	2065	1150	2500	2700	
1600	1200	25.2	20.4	2300	1180	2800	3000	
1600	1400	25.2	22.8	2300	1210	3208	3444	
1600	1600	25.2	25.2	2480	1240	3586	3854	

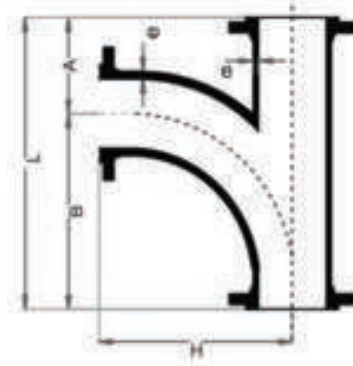

	Size/DN		e	A	B	H	L
	Body	Branch					
All Flange Radial Tee	80	80	7	165	380	380	545
	100	100	7.2	180	400	400	580
	150	150	7.8	220	450	450	670
	200	200	8.4	260	500	500	760
	250	250	9	350	550	550	900
	300	300	9.6	400	600	600	1000
	350	350	10.2	450	650	650	1100
	400	400	10.8	500	700	700	1200
	450	450	11.4	550	750	750	1300
	500	500	12	600	800	800	1400
	600	600	13.2	700	900	900	1600
	700	700	14.4	800	1000	1000	1800
	800	800	15.6	900	1100	1100	2000
	900	900	16.8	1000	1200	1200	2200
	1000	1000	18	1100	1300	1300	2400
	1100	1100	19.2	1200	1400	1400	2600
1200	1200	20.4	1300	1500	1500	2800	

Dismantling Joints	Size/DN
	80
	100
	125
	150
	200
	250
	300
	350
	400
	450
	500
	600
	700
	750
	800
	900
1000	
1100	
1200	
1400	
1500	
1600	

Double Flange Pipe	Size/DN
	80
	100
	125
	150
	200
	250
	300
	350
	400
	450
	500
	600
	700
	750
	800
	900
1000	
1100	
1200	
1400	
1500	
1600	

Flange Spigot Pipe With Puddle	Size/DN
	80
	100
	125
	150
	200
	250
	300
	350
	400
	450
	500
	600
	700
	750
	800
	900
1000	
1100	
1200	
1400	
1500	
1600	

Socket Flange Pipe	Size/DN
	80
	100
	125
	150
	200
	250
	300
	350
	400
	450
	500
	600
	700
	750
	800
	900
1000	
1100	
1200	
1400	
1500	
1600	

Double Flange Pipe With Puddle	Size/DN
	80
	100
	125
	150
	200
	250
	300
	350
	400
	450
	500
	600
	700
	750
	800
	900
1000	
1100	
1200	
1400	
1500	
1600	

Mechanical Joint Gland	Size/DN
	80
	100
	125
	150
	200
	250
	300
	350
	400
	450
	500
	600
	700
	750
	800
	900
	1000
	1100
	1200
1400	
1500	
1600	

Loose Flange	Size/DN
	80
	100
	125
	150
	200
	250
	300
	350
	400
	450
	500
	600

Electrolock Socket	Size/DN
	80
	100
	125
	150
	200
	250
	300
	350
	400
450	
500	
600	

RJT Gland`	Size/DN
	700
	800
	900
	1000
	1100
	1200

Fastener For 'm' Type Mechanical Joints	Size/DN
	M20
	M24
	M27
	M30

EMJ Gland`	Size/DN
	80
	100
	125
	150
	200
	250
	300
	350
	400
	450
	500
600	

Locking Bar	Size/DN
	80
	100
	125
	150
	200
	250
	300
	350
	400
450	
500	

RJT Bolt	Size/DN
	M22
	M27

Washer	Size/DN
	1200

Locking Plate	Size/DN
	600

Clamping Flange for Restrained Express Lock	Size/DN
	80
	100
	150
	200



We have already delivered our consignment to more than 50 countries.

**Thank you. For your valuable time!**

## Contact Us

and let one of our friendly staff help with your requirements.

✉ [export@onetouchexim.com](mailto:export@onetouchexim.com)

🖱 [www.onetouchexim.com](http://www.onetouchexim.com)

📞 +91 9315412619

📍 Plot No. E-21C, Sector-8,  
Noida, UP-201301, India